

FARAD[®]

made in Italy

Evolution Srl unipersonale, Via A. De Gasperi 26, 12040 Sanfrè (CN) Italy
www.faradworld.com tel. 011 9713719 - n° verde 800984229

BS 002 - 1

ALFA 159 SW 2006-2011 (no railing)

ALFA 159 2005-2011

LAND ROVER DISCOVERY SPORT 2015>

5



I Istruzioni di montaggio

F Instructions de montage

PL Instrukcje wbudowania

D Einbauanleitung

GB Fitting instructions

E Instrucciones de montaje

NL Inbouwhandleiding

SWE Montageanvisnin

KIT BS

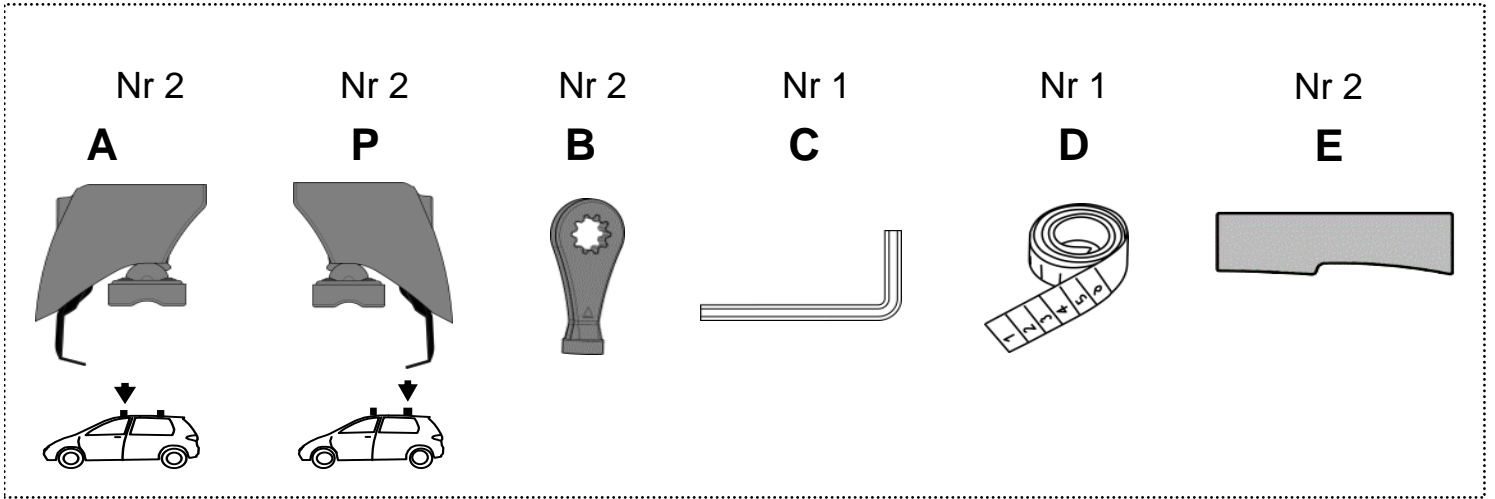

KIT ALU

+

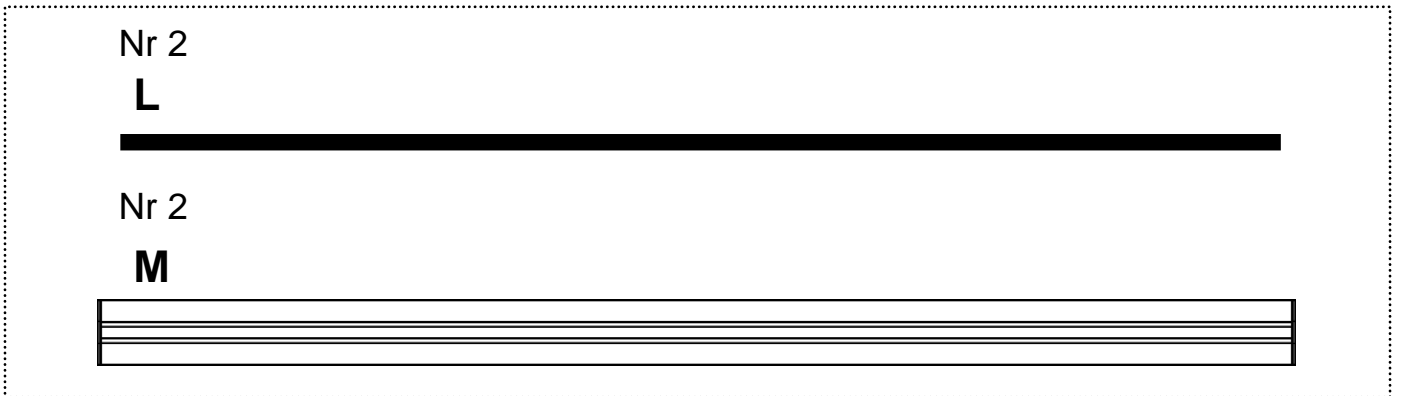

=

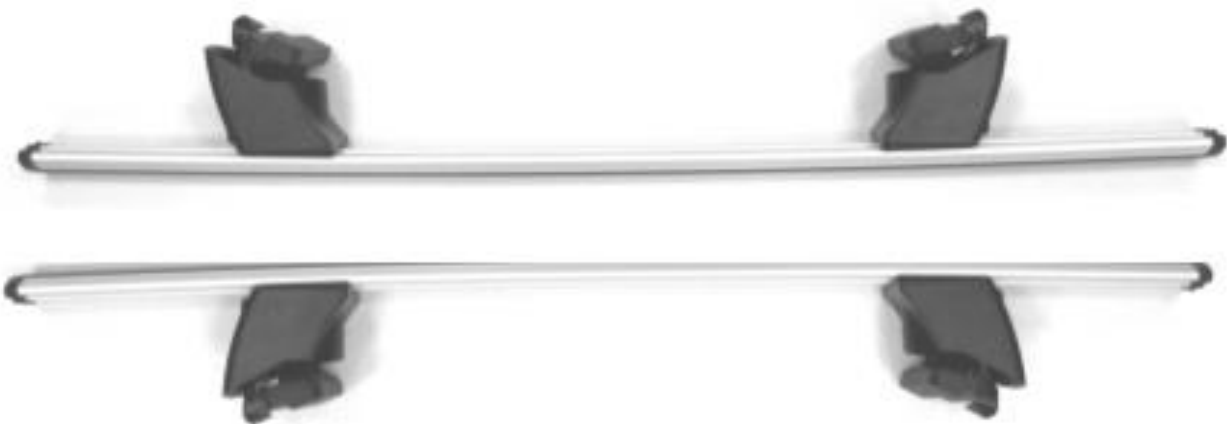

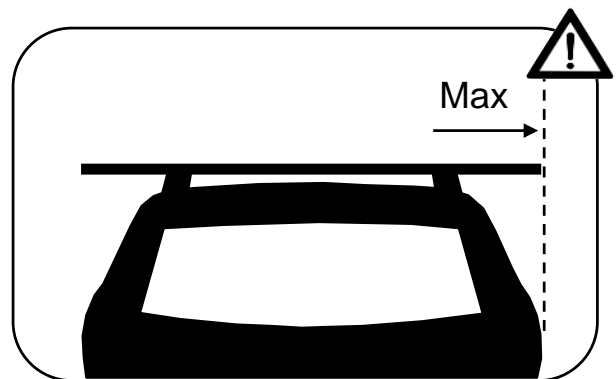
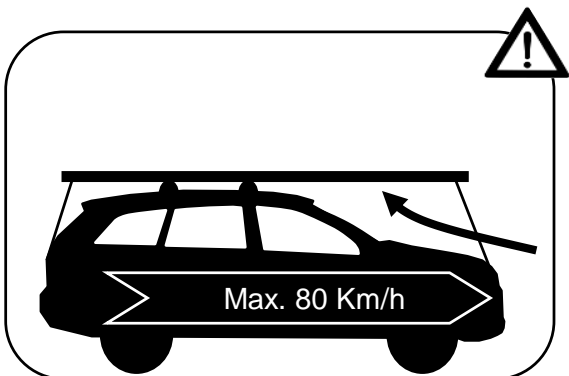
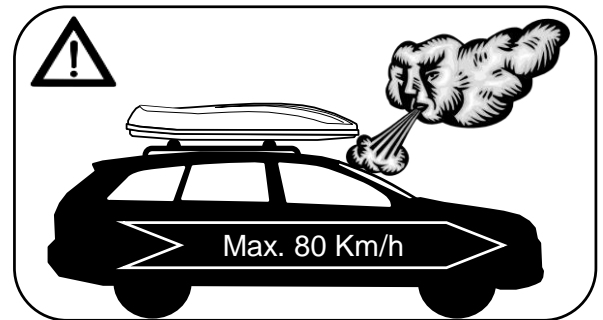
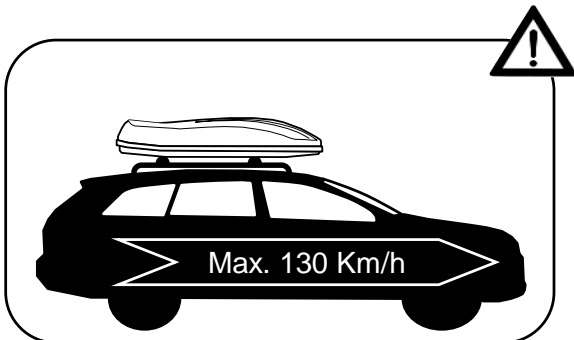
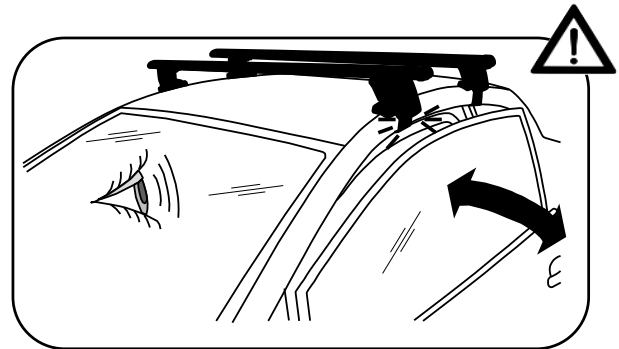
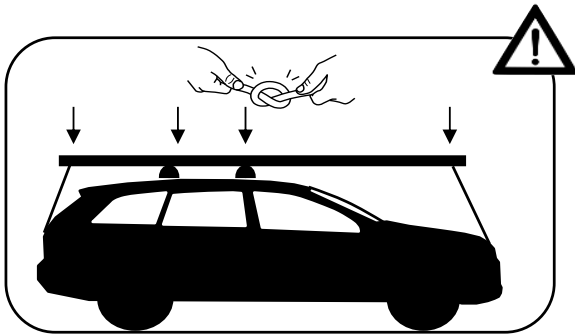
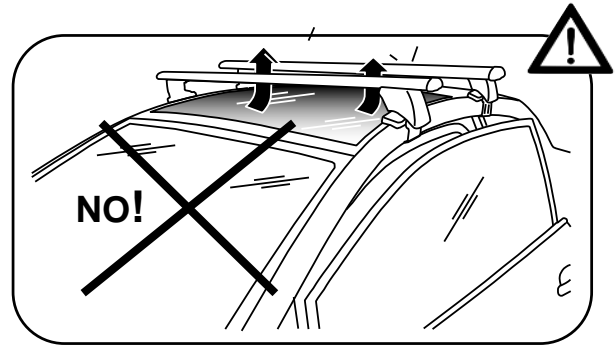
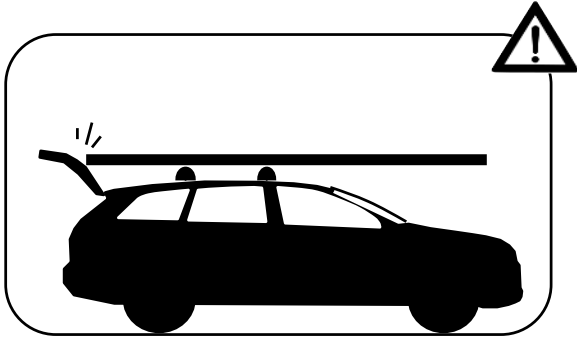
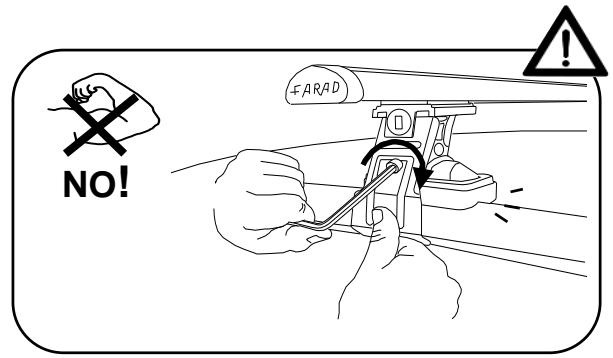
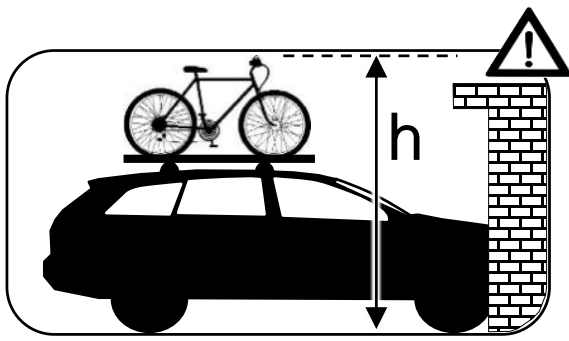

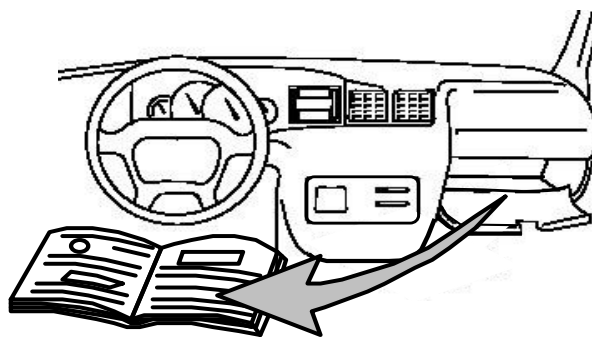
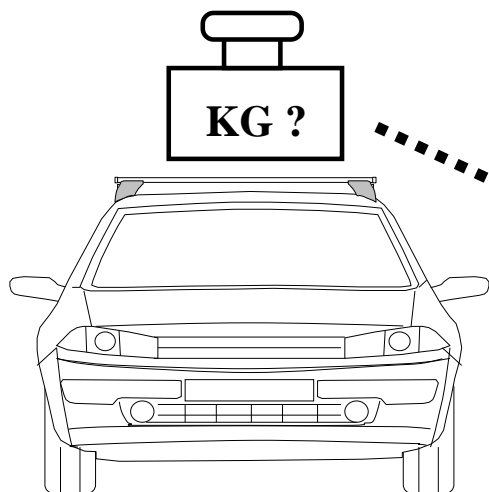

- I Controllare carico del tetto sul manuale dell'auto
- PL Sprawdz ładowność dachu w instrukcji
- GB Check roof load capacity in car instruction
- NL check de handleiding belasting van het dak van de auto
- F vérifier le chargement manuel du toit de la voiture
- D überprüfen Sie die manuelle Beladung der Autodach
- E comprobar la carga manual del techo del coche
- SWE kontrollera manuell inläggning på taket av bilen

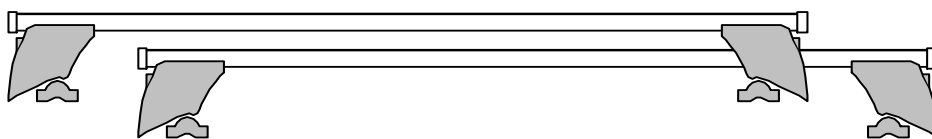
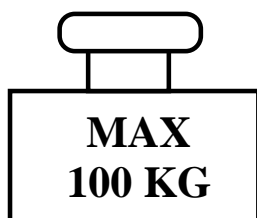
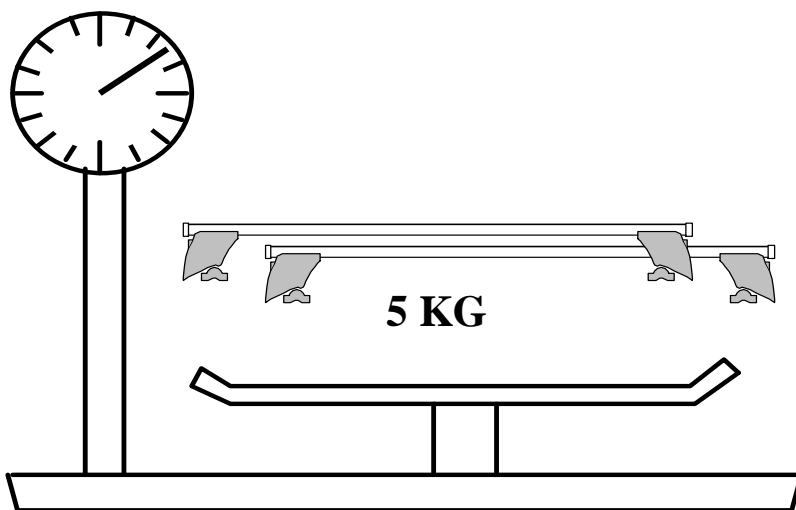

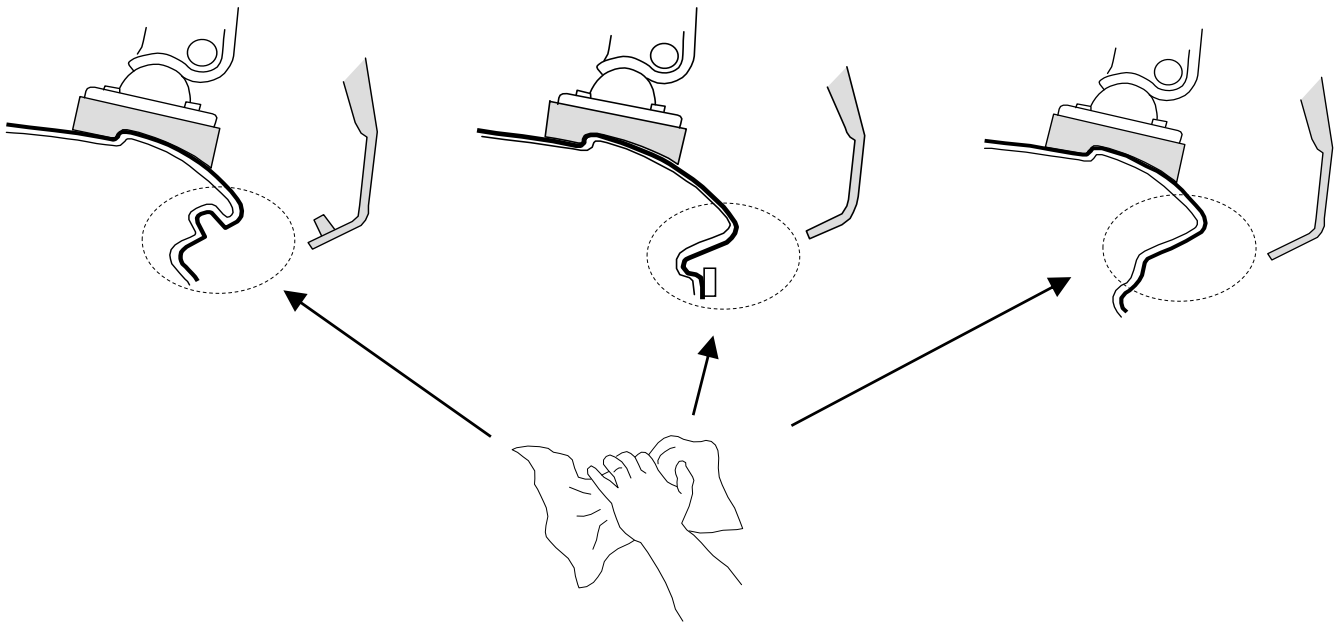
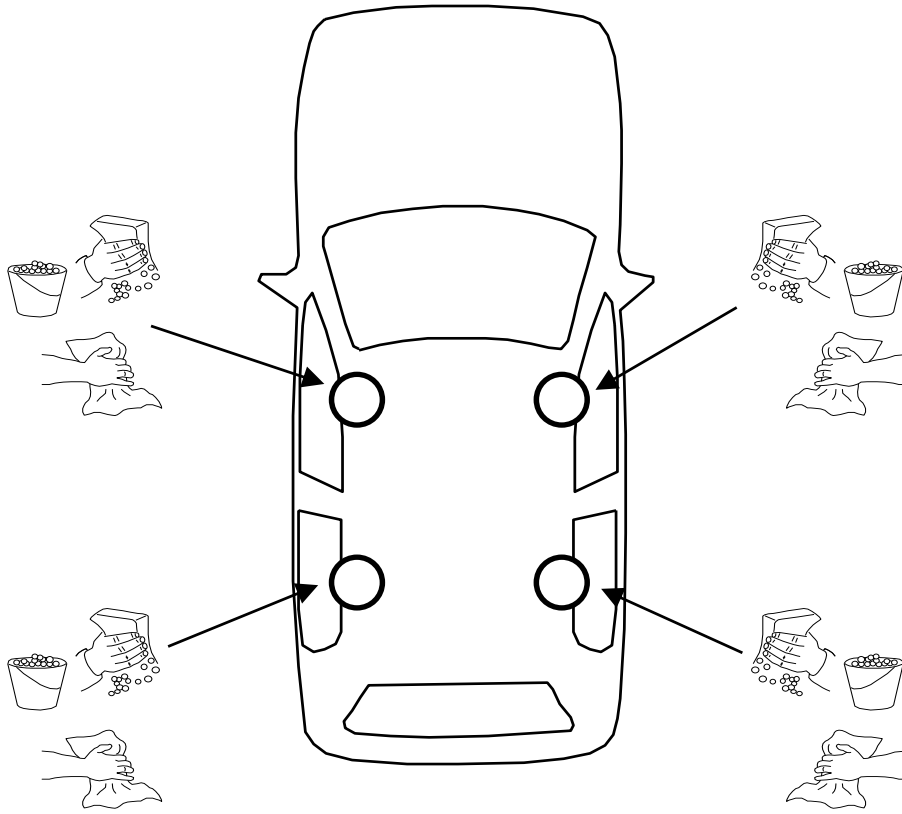

I Montaggio Barra Anteriore
PL Montaż Bagażnika Bazowego Tylnego
D Montage Vorderes Dachträgers
SWE Montering Av Främre Lasthållaren

F Fixation Barre Avant
GB Fitting Front Roof Bar
NL Montage Voorste Dakdrager
E Fijación Barra Frontal

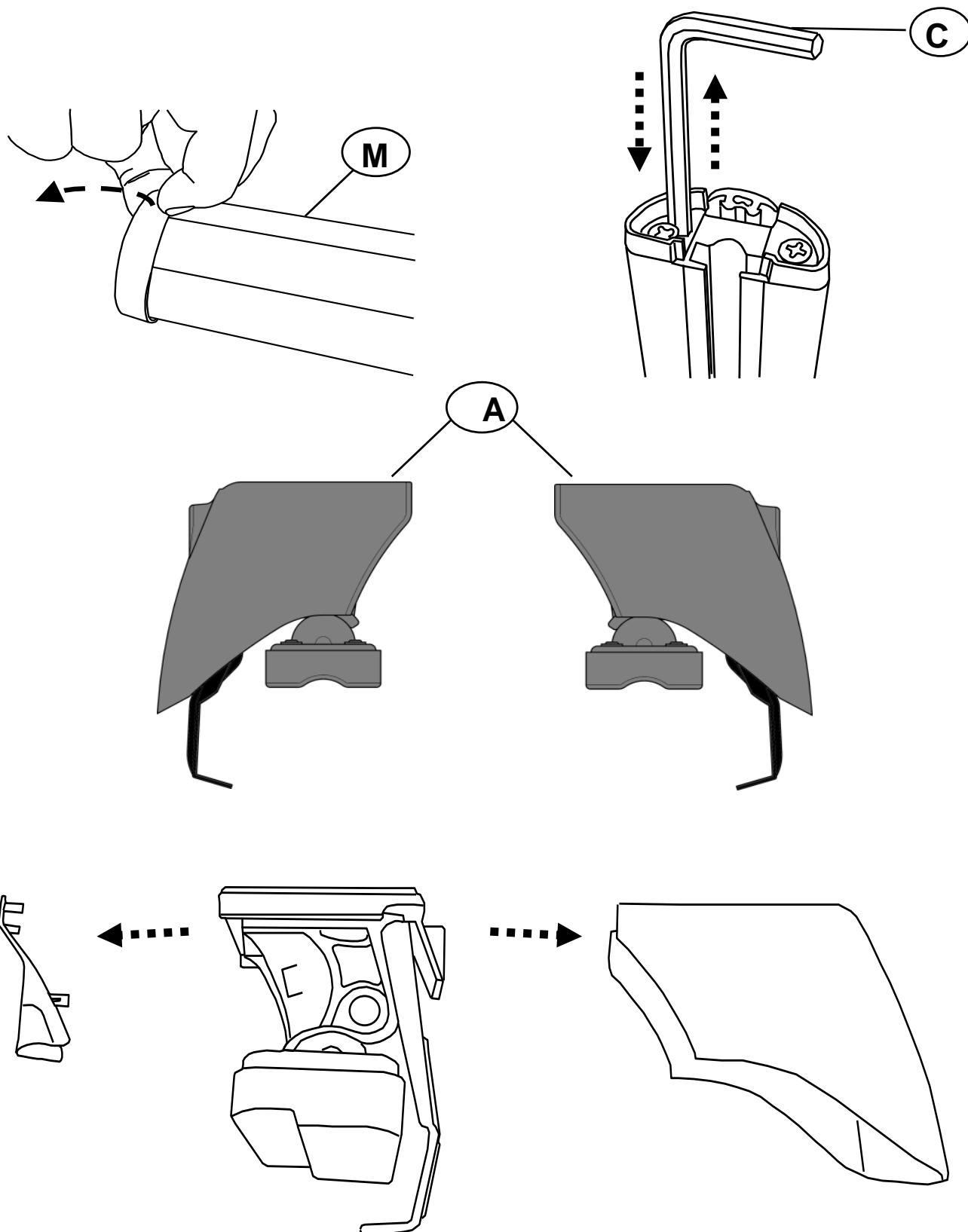



M

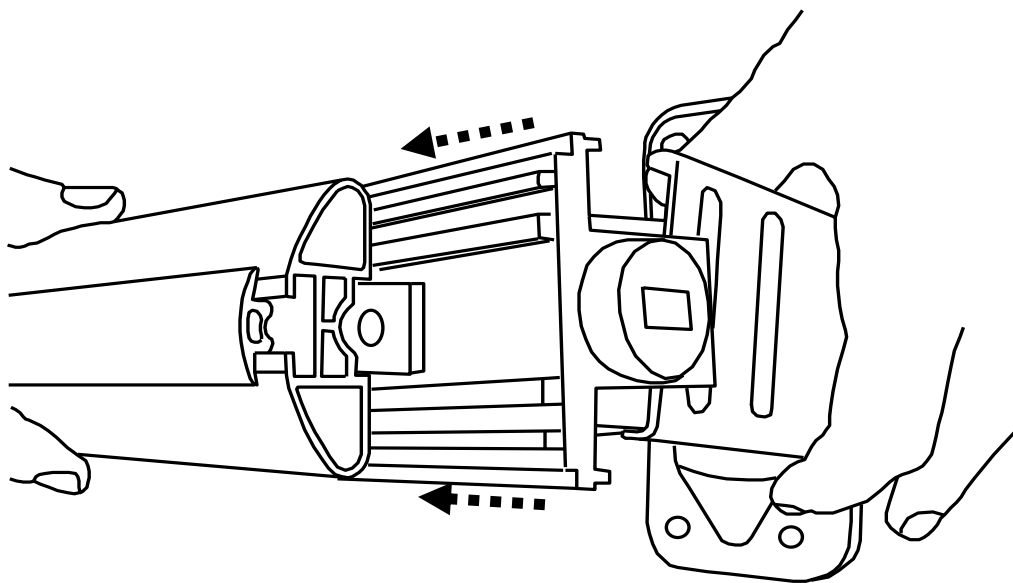
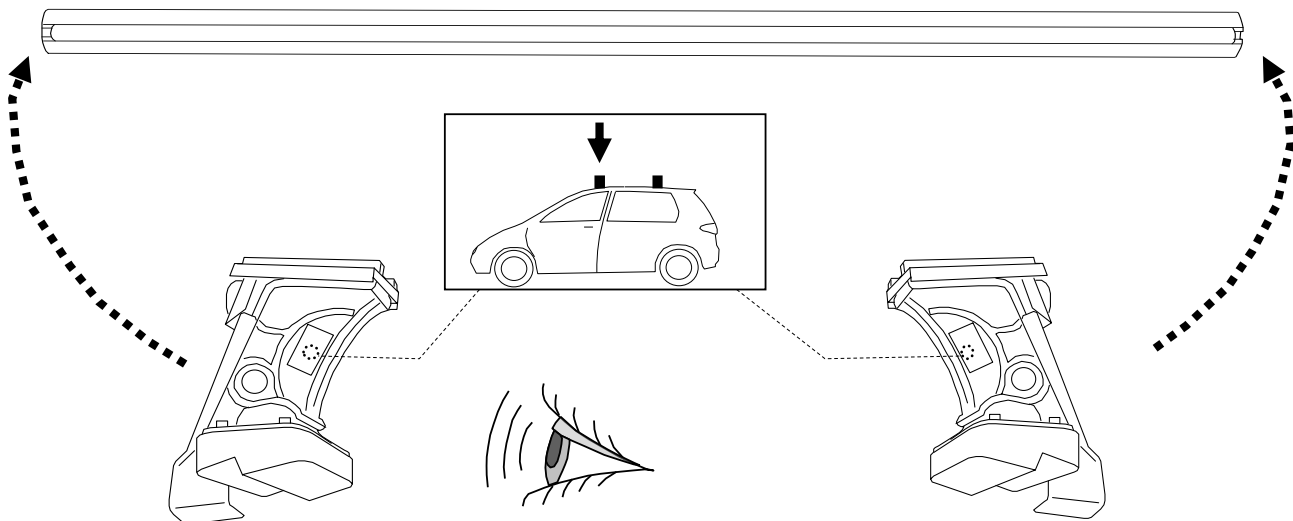

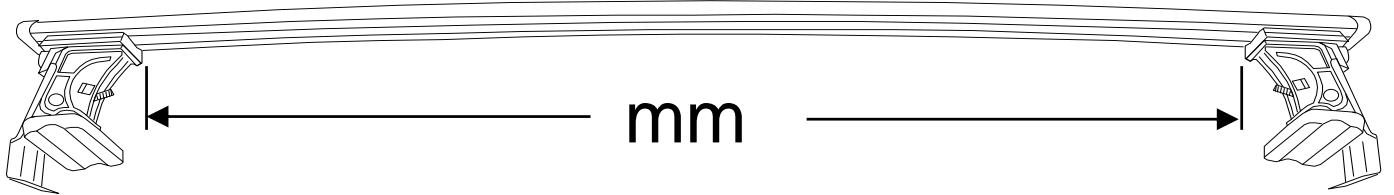

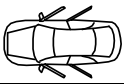
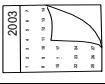

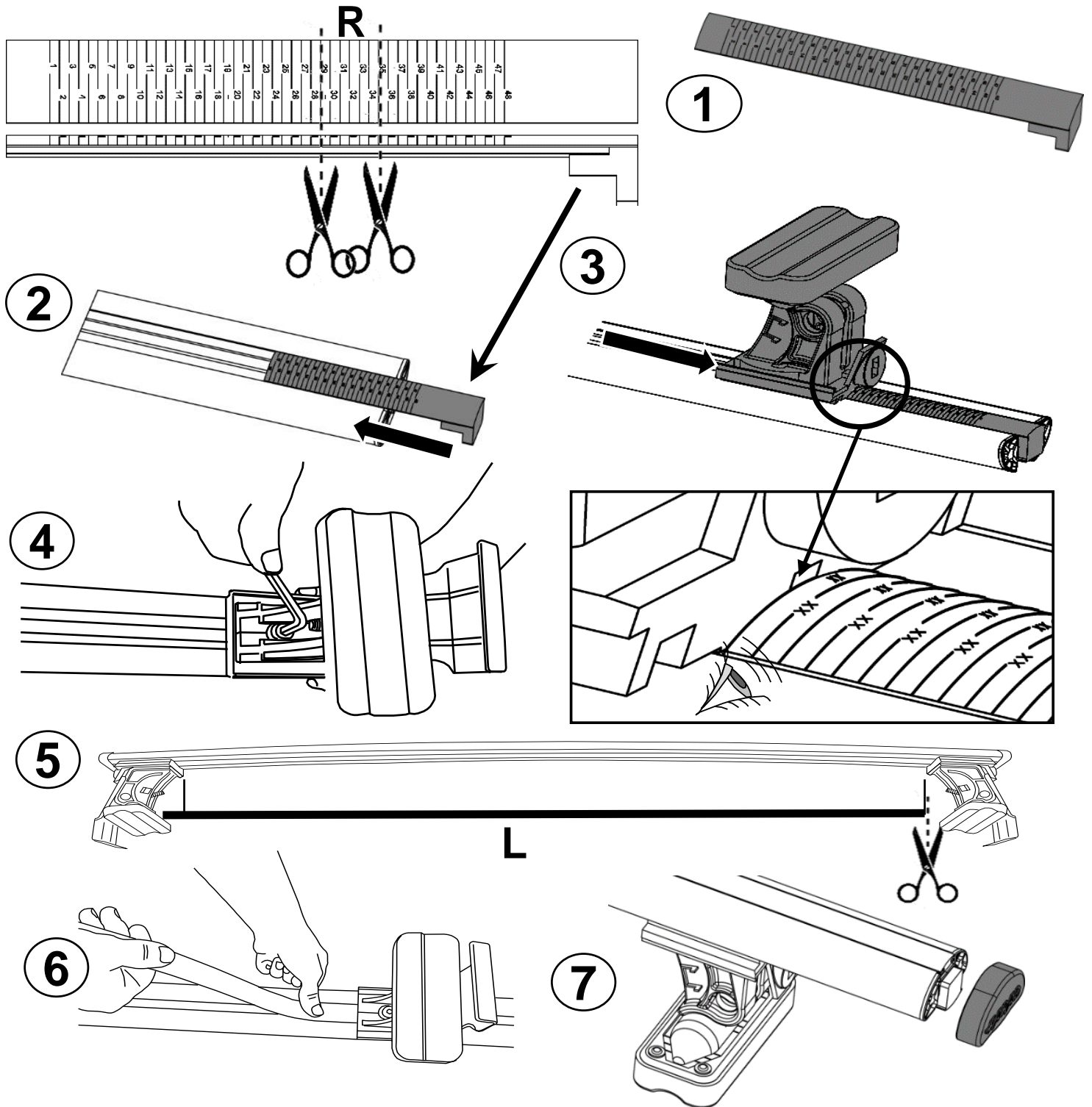
			R	mm
ALFA	159 SW	5	2006-2011	R= 36 945
ALFA	159	5	2005-2011	R= 36 945
LAND ROVER	DISCOVERY SPORT	5	2015>	R= 30 1115

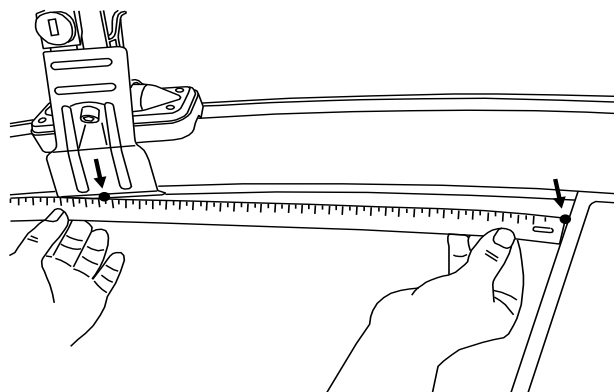
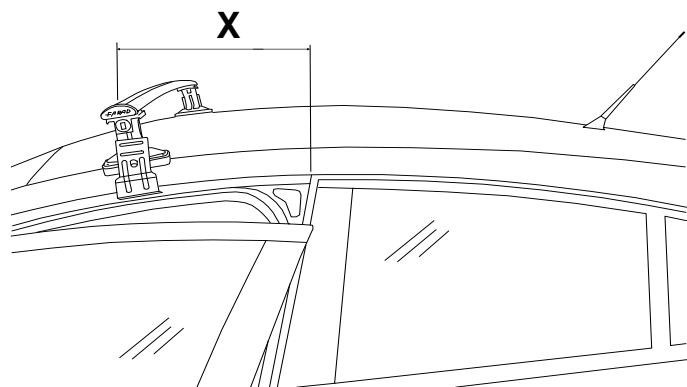
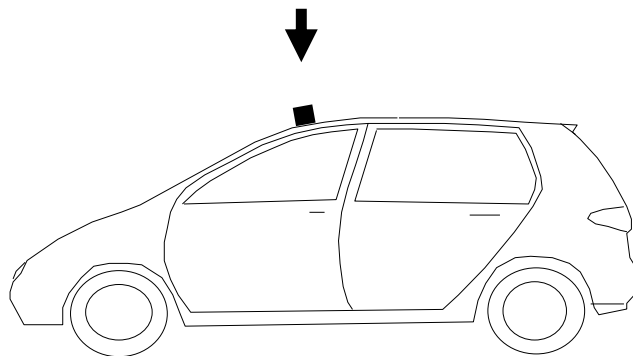



				X
ALFA	159 SW	5	2006-2011	X= 230
ALFA	159	5	2005-2011	X= 230
LAND ROVER	RANGE ROVER	5	2015>	X= 100

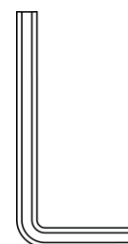
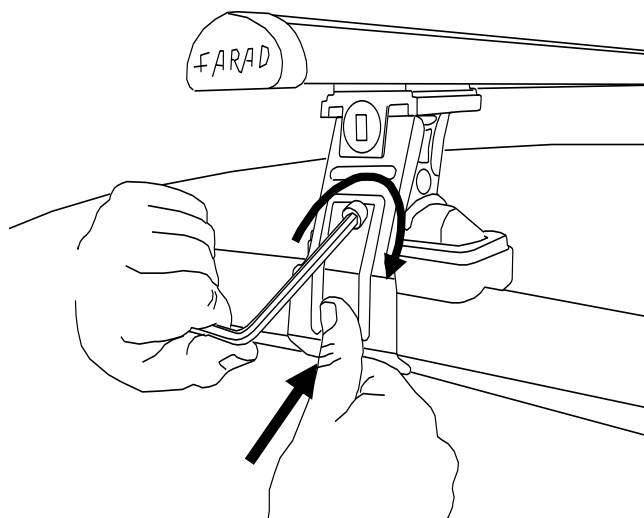
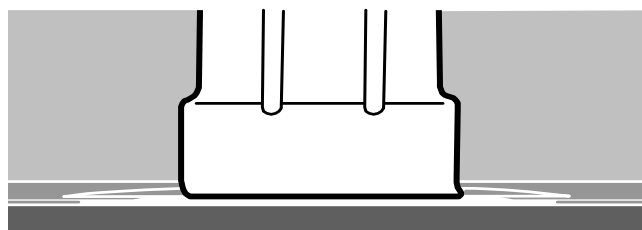
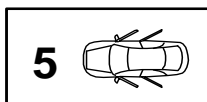

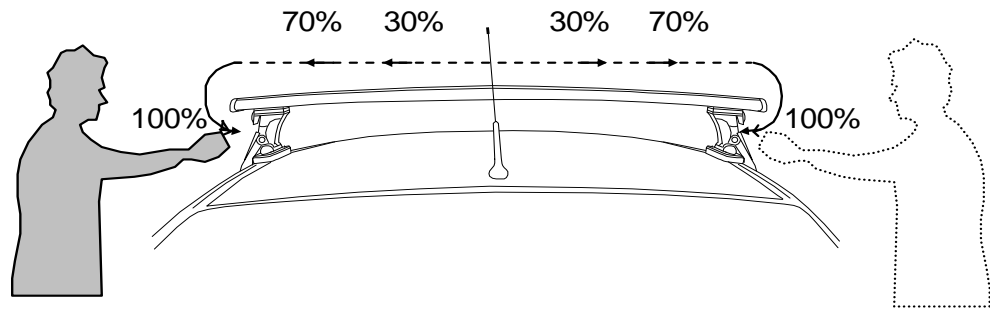

- | | | | |
|----|---|-----|------------------------------------|
| I | Alternare il fissaggio delle viti | F | Serrer alternativement chaque côté |
| PL | Śruby dokręcaj naprzemiennie | D | Die Schrauben abwechselnd anziehen |
| GB | Tighten alternately | E | Anretar alternativamente |
| NL | Afwisselend aan de linker- en de rechterkant aandraaien | SWE | Dra åt växelvis |

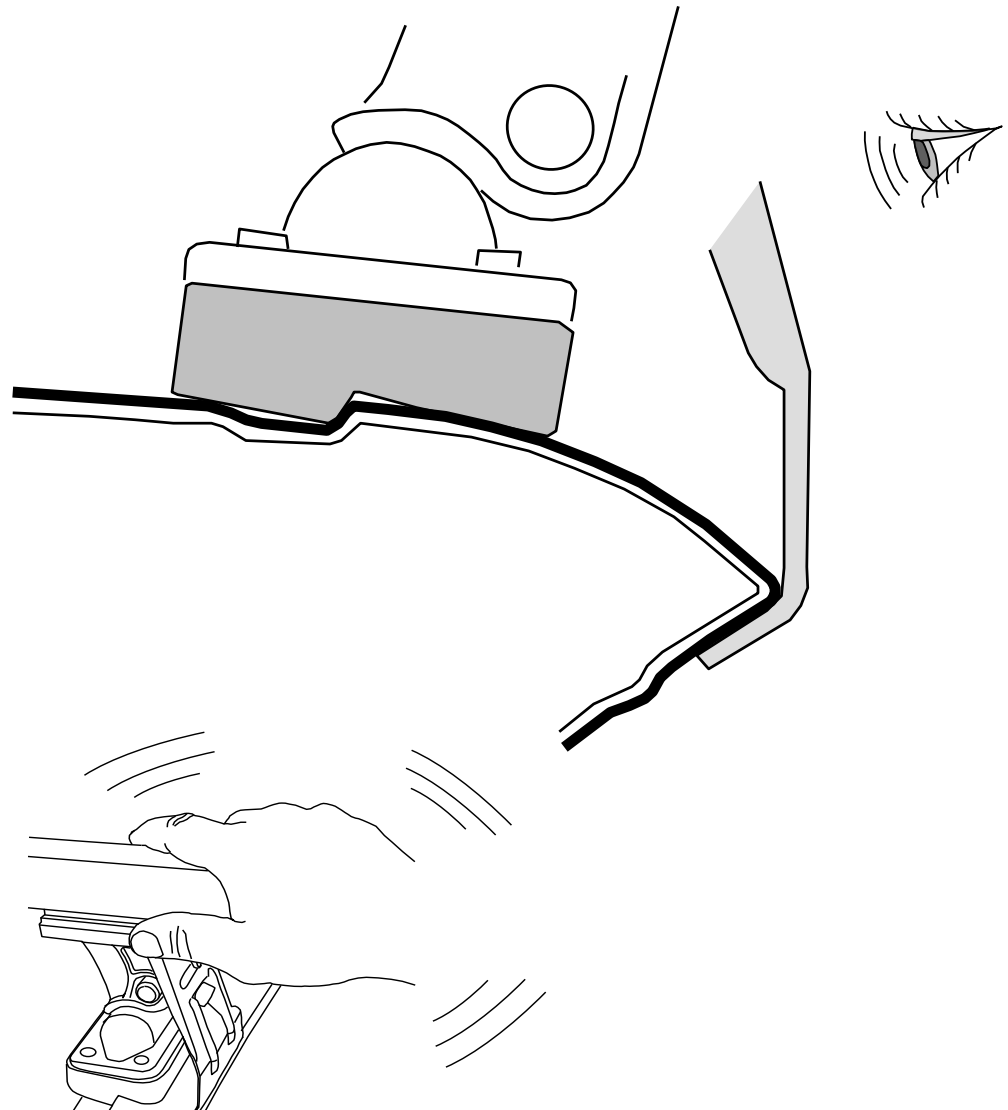
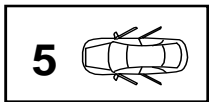

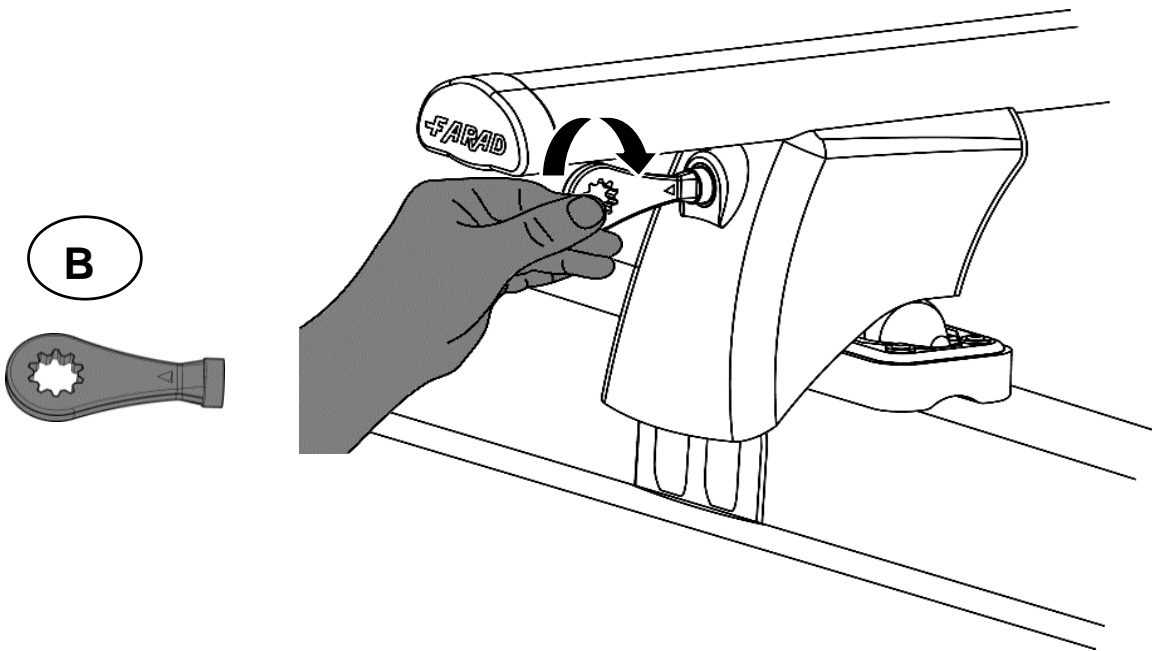
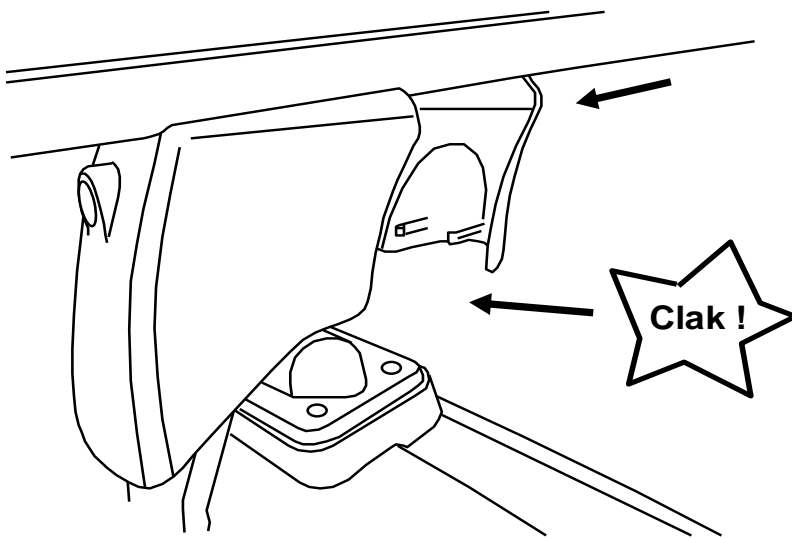
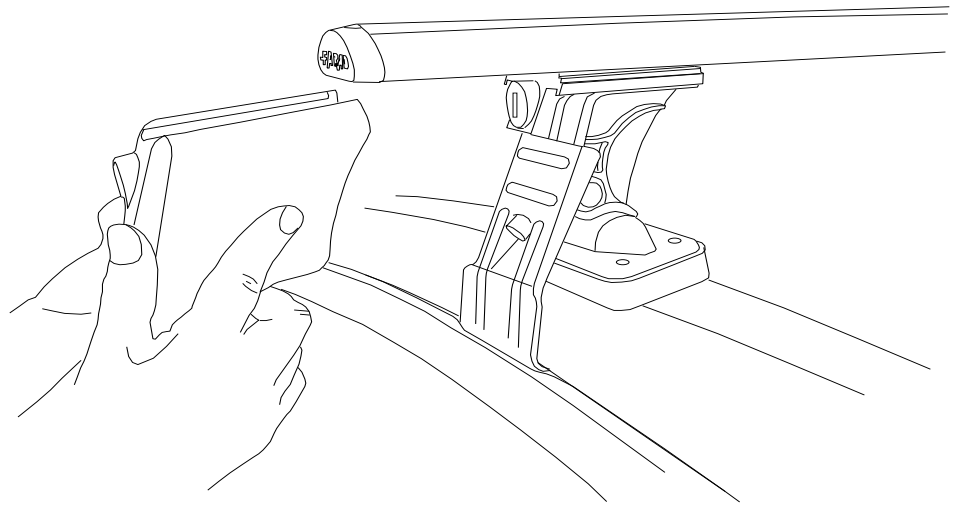

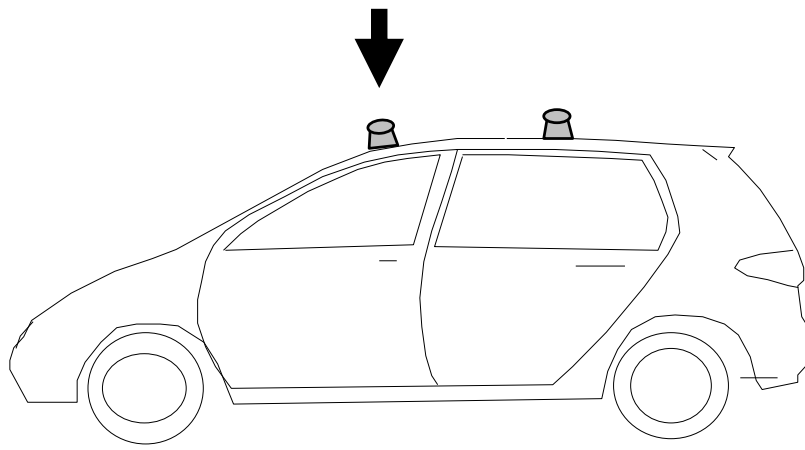

- I** CONTROLLARE PERIODICAMENTE IL FISSAGGIO DELLE VITI
- PL** OKRESOWO SPRAWDZAJ MOCOWANIE ŚRUB
- GB** CHECK THE SCREW FASTENING PERIODICALLY
- D** REGELMÄSSIG ÜBERPRÜFEN DIE BEFESTIGUNG DER SCHRAUBEN
- SWE** REGELBUNDET KONTROLLERA OM FASTSTÄLLANDE AV SKRUVARNA
- F** VERIFIEZ LA FIXATION DES VIS PERIODIQUEMENT

I **Montaggio barra posteriore**

PL **Montaż Bagażnika Bazowego Przedniego**

SWE **Montering Främre Lasthållaren**

NL **Montage Achterste Dakdrager**

F **Fixation Barre Arriere**

GB **Fitting Rear Roof Bar**

E **Fijación Barra Trasera**

D **Montage Heckdachträgers**

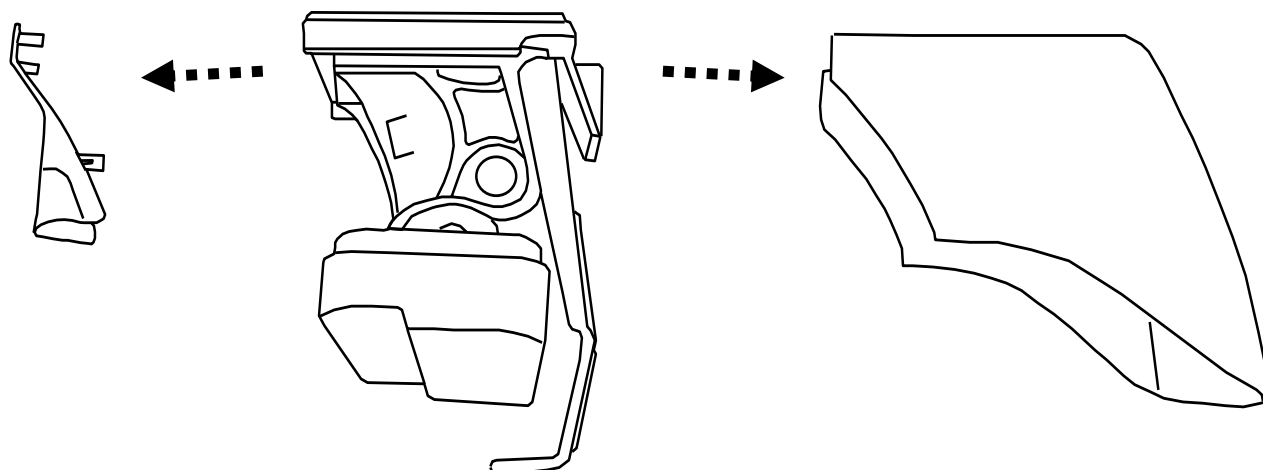
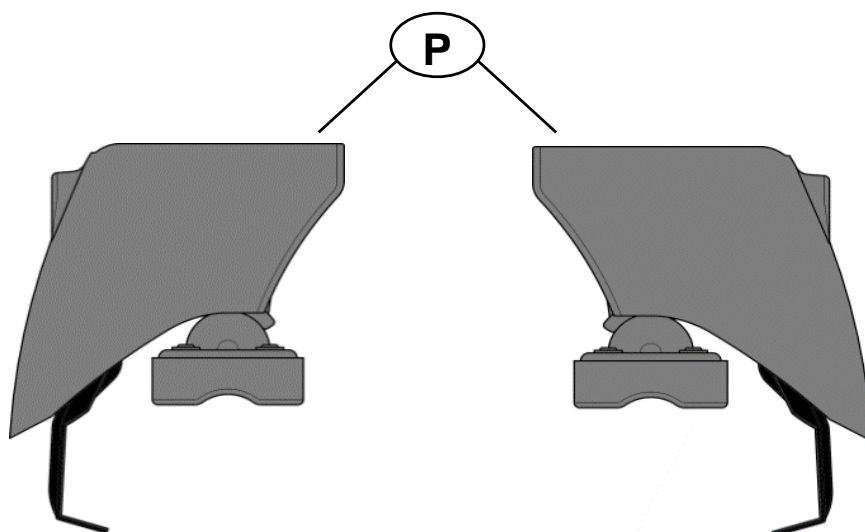
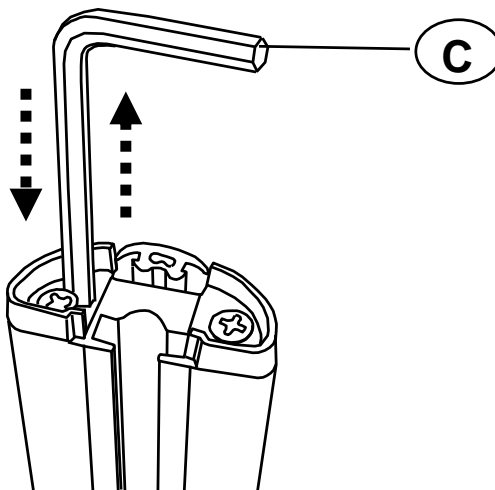
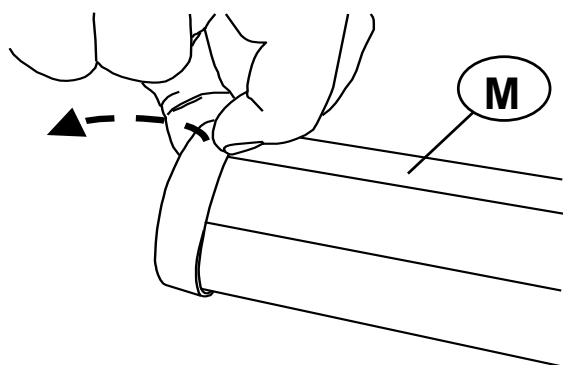



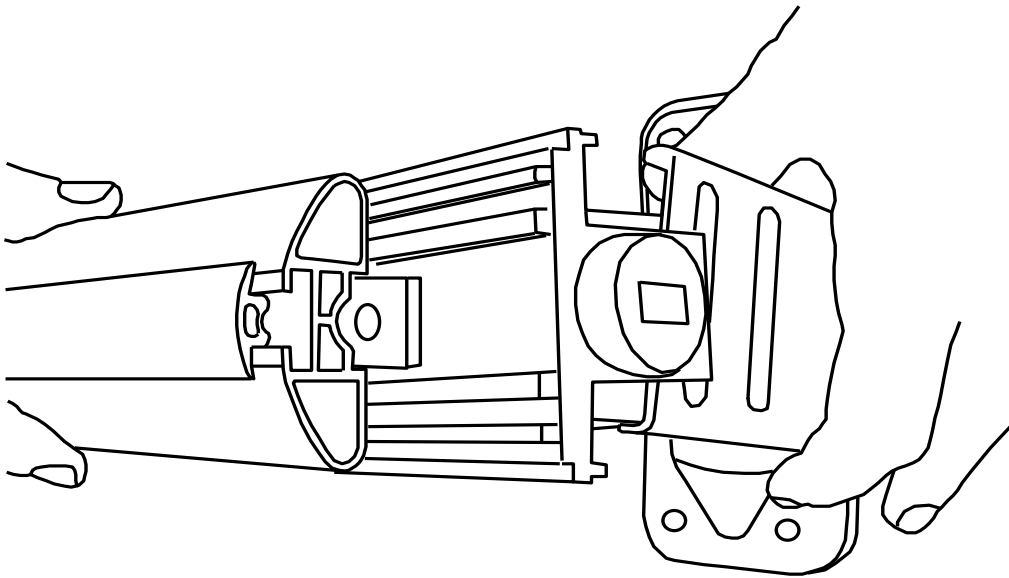
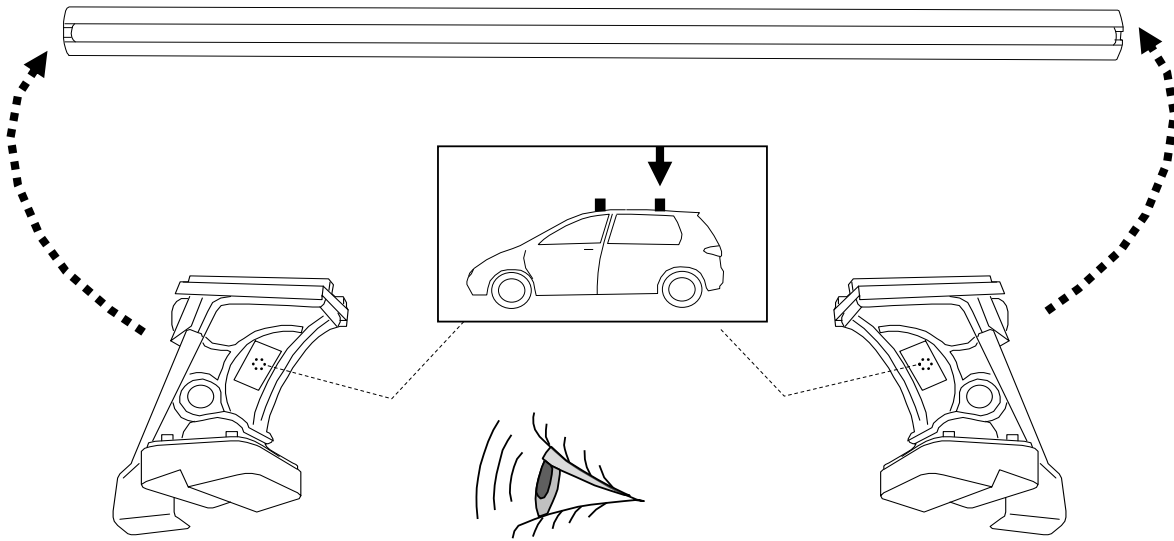

M

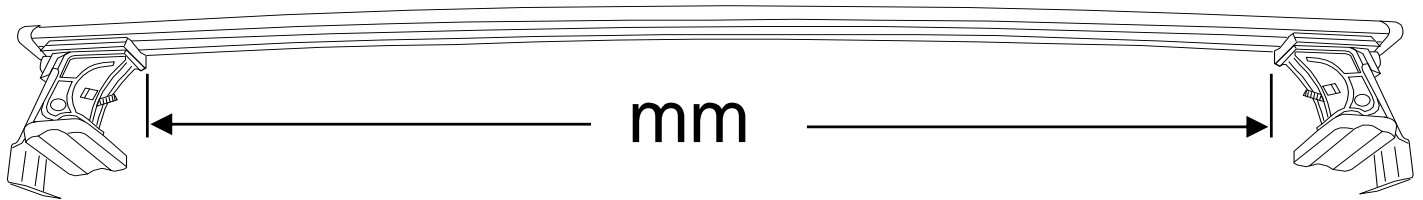



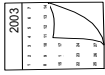

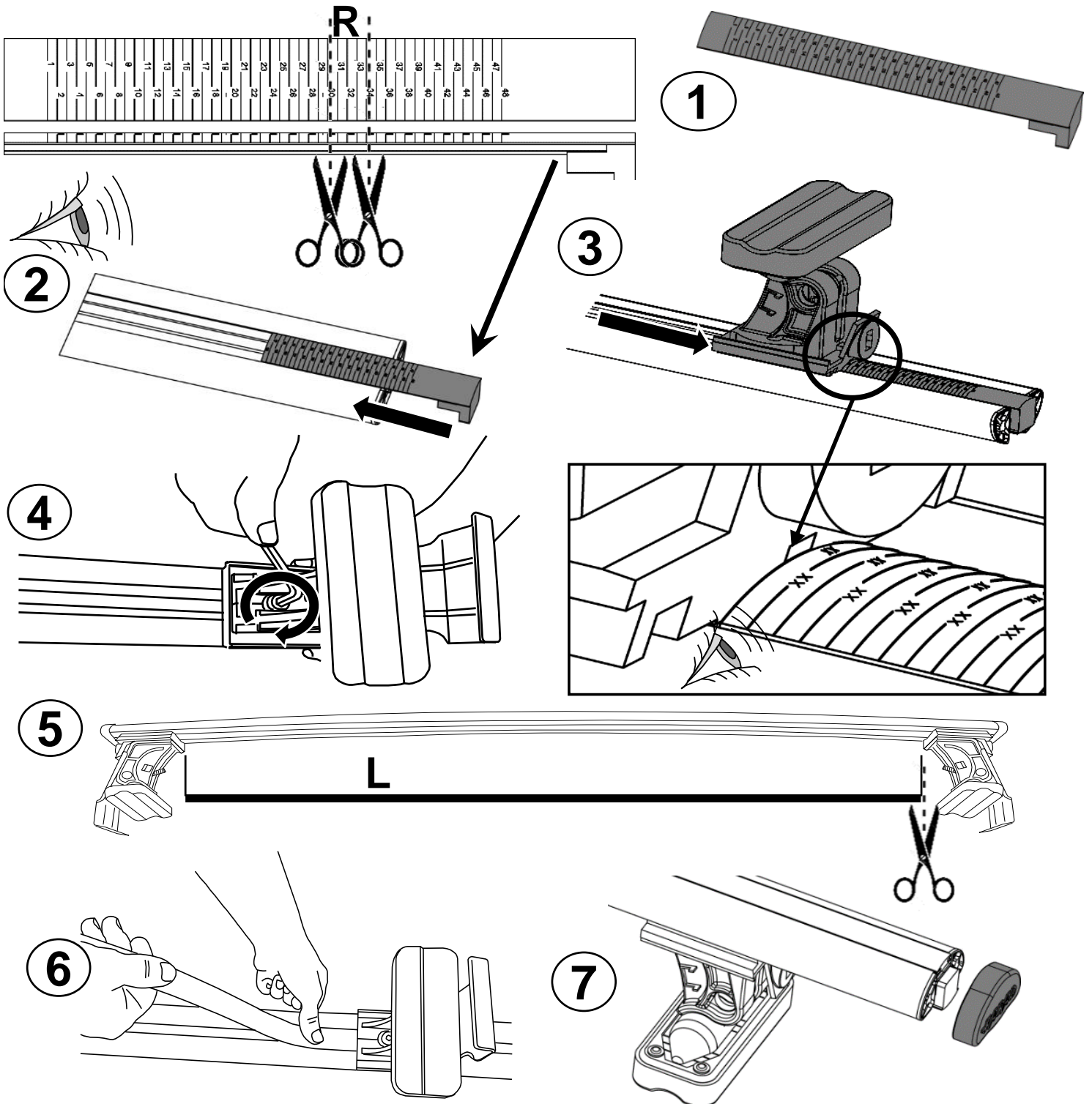
			R	mm
ALFA	159 SW	5	2006-2011	R= 34 930
ALFA	159	5	2005-2011	R= 34 930
LAND ROVER	DISCOVERY SPORT	5	2015>	R= 30 1115

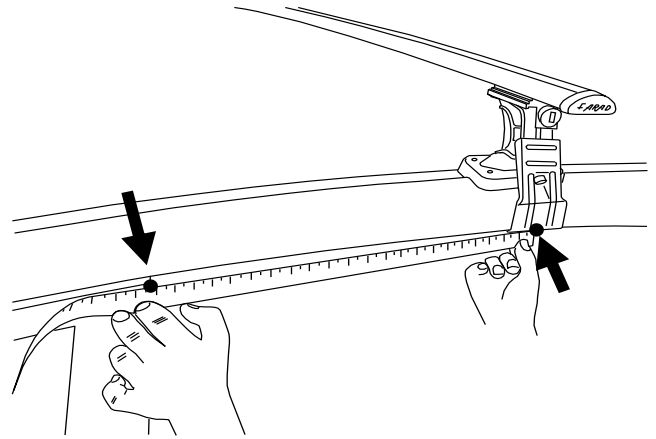
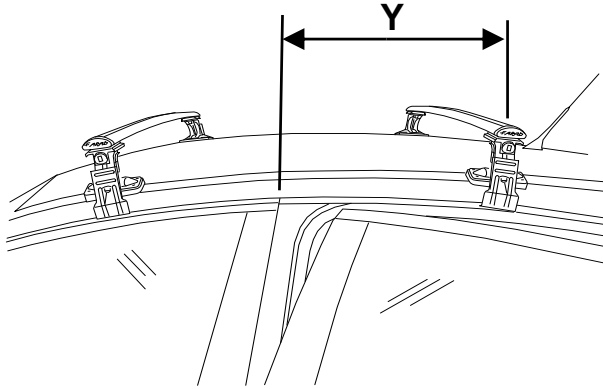
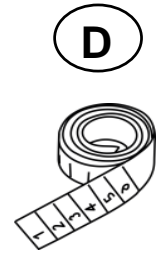
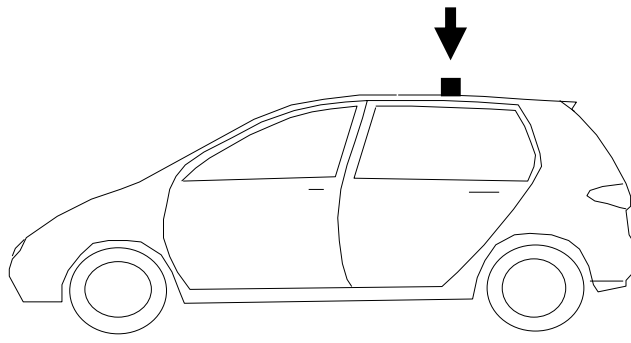



				Y
ALFA	159 SW	5	2006-2011	Y= 400
ALFA	159	5	2005-2011	Y= 400
LAND ROVER	DISCOVERY SPORT	5	2015>	Y= 600

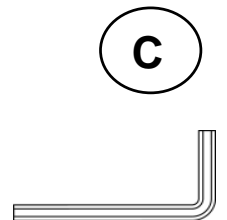
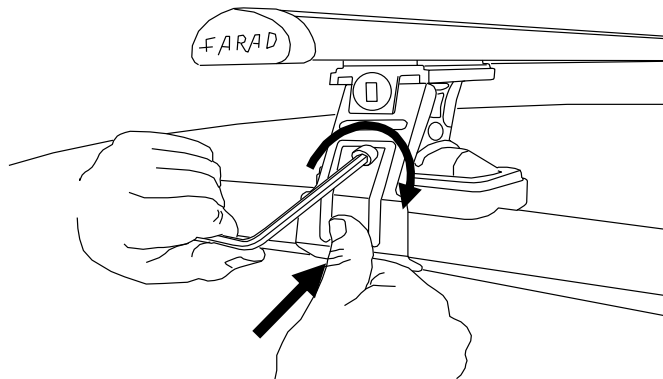
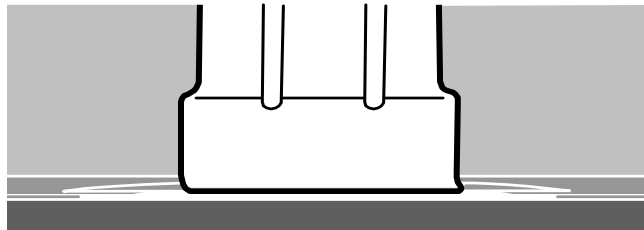
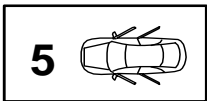

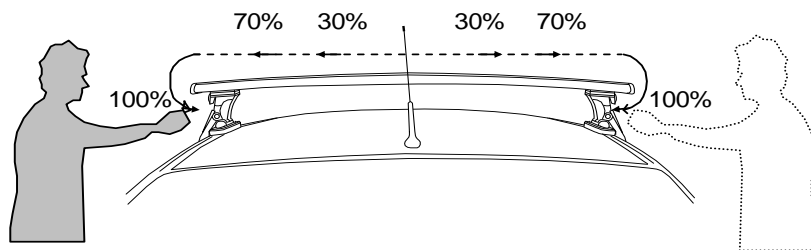

- | | | | |
|---|---|-----|------------------------------------|
| I | Alternare il fissaggio delle viti | F | Serrer alternativement chaque côté |
| P | Śruby dokręcaj naprzemiennie | D | Die Schrauben abwechselnd anziehen |
| G | Tighten alternately | E | Apretar alternativamente |
| N | Afwisselend aan de linker- en de rechterkant aandraaien | SWE | Dra åt växelvis |

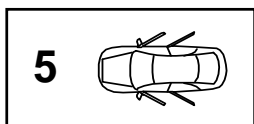

ALFA 159 / 159 SW

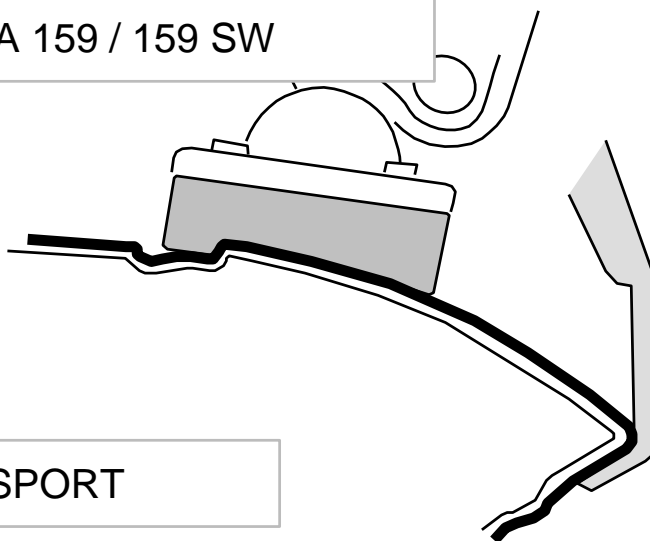

LAND ROVER DISCOVERY SPORT

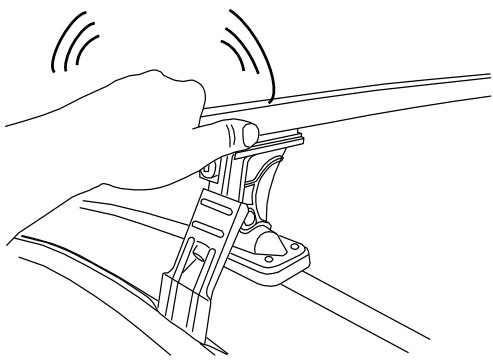
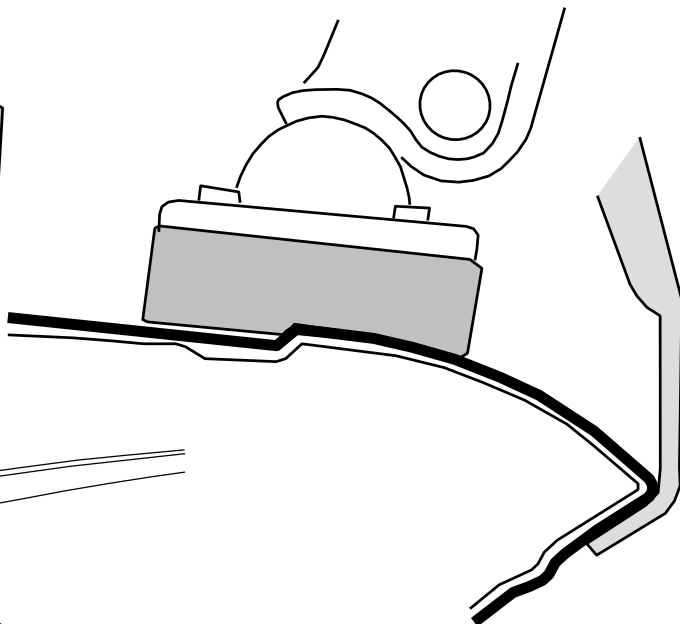
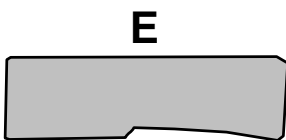

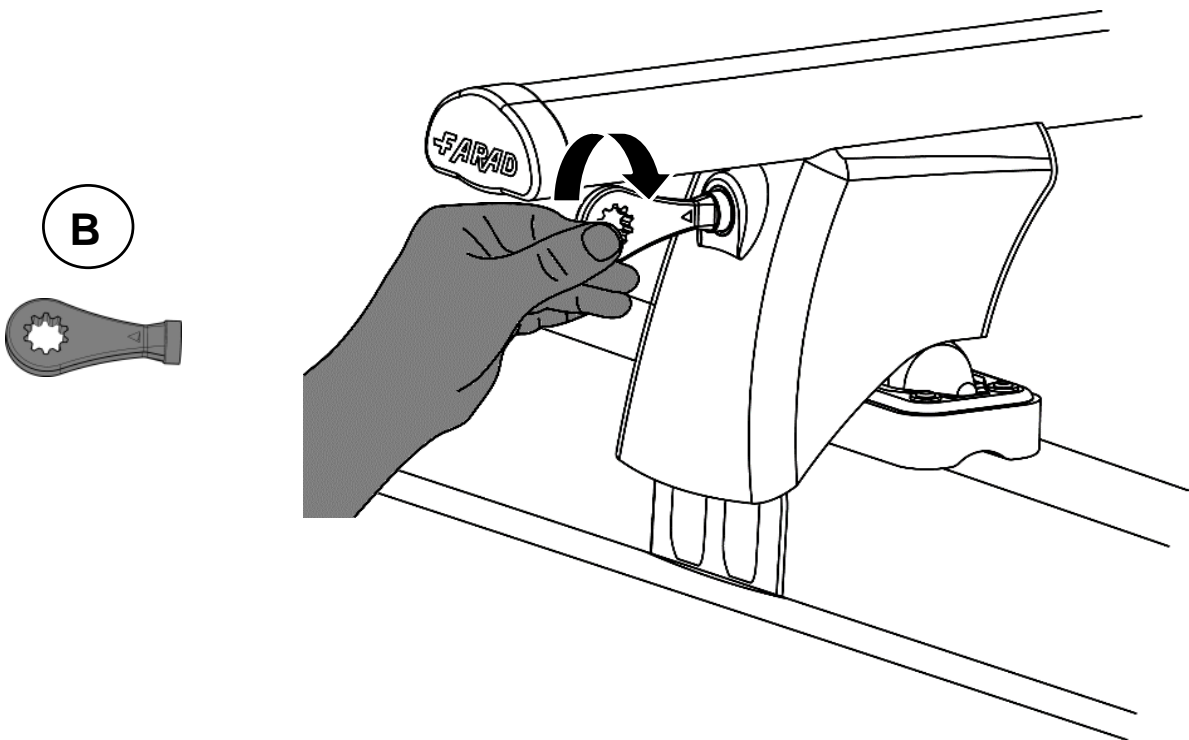
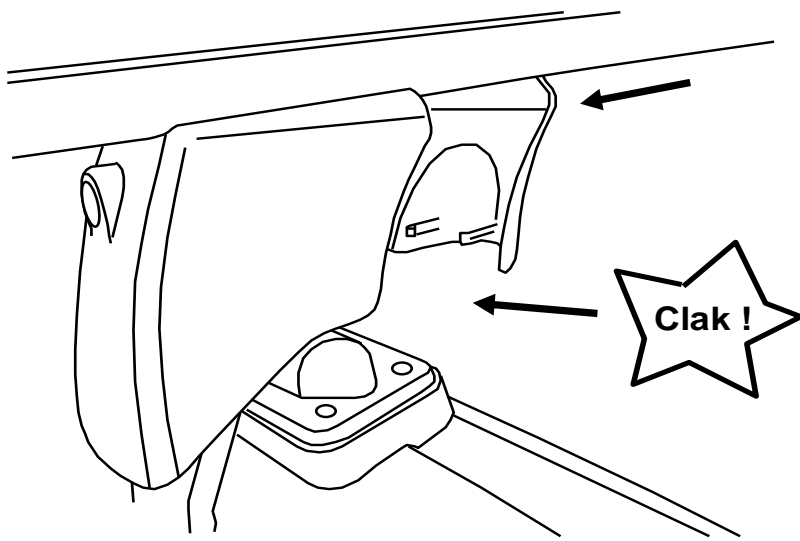
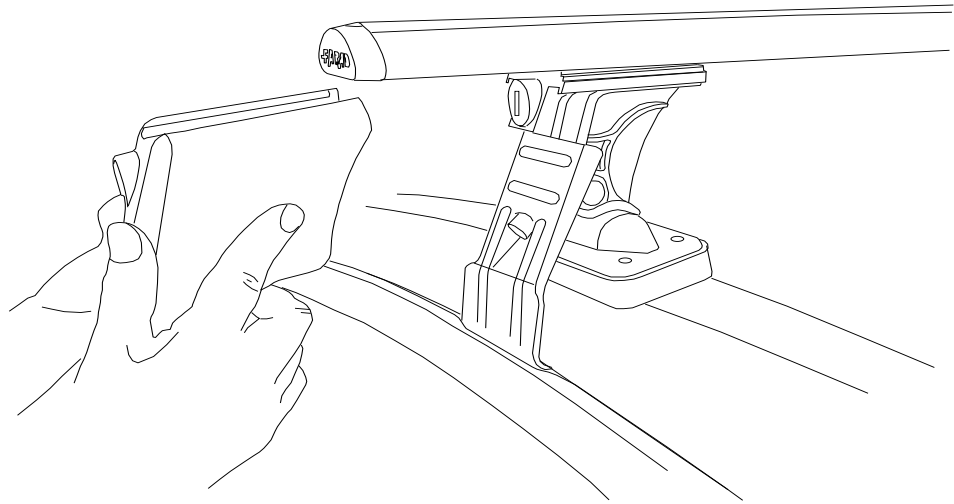

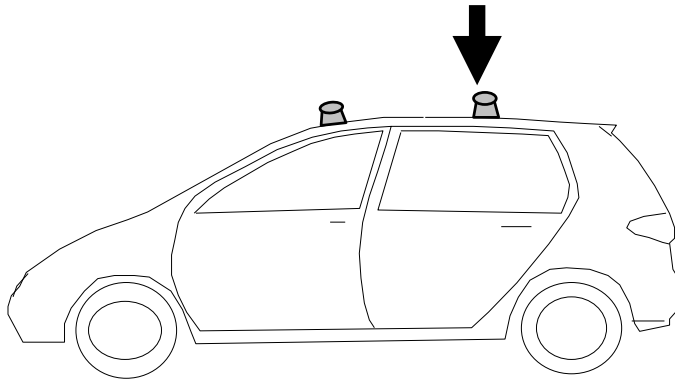

ALFA 159 / 159 SW

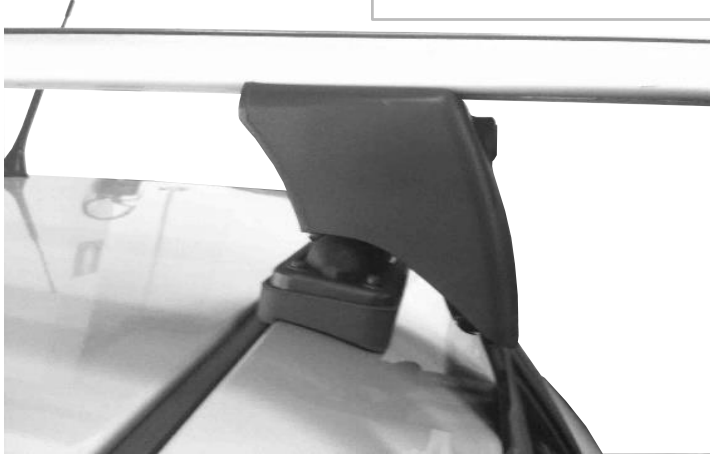

LAND ROVER DISCOVERY SPORT



- I** CONTROLLARE PERIODICAMENTE IL FISSAGGIO DELLE VITI
- PL** OKRESOWO SPRAWDZAJ MOCOWANIE ŚRUB
- GB** CHECK THE SCREW FASTENING PERIODICALLY
- D** REGELMÄSSIG ÜBERPRÜFEN DIE BEFESTIGUNG DER SCHRAUBEN
- SWE** REGELBUNDET KONTROLLERA OM FASTSTÄLLANDE AV SKRUVARNA
- F** VERIFIEZ LA FIXATION DES VIS PERIODIQUEMENT



RICAMBI - SPARE PARTS

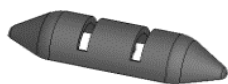

PIEDE GIREVOLE
90341 / 2

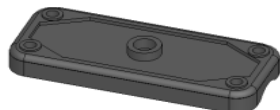

PIEDE FISSO
90341 / 15

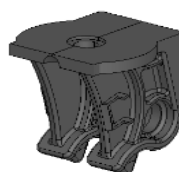

SUPPORTO CENTRALE
90341 / 1

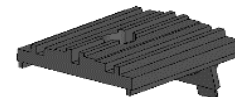

SUPPORTO BARRA
90341 / 5



SOTTO PIEDE SP01
90341 / 3



SOTTO PIEDE SP03
90341 / 16



SOTTO PIEDE SP04
90341 / 13



SOTTO PIEDE SP07
90341 / 11

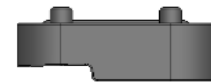

SOTTO PIEDE SP08
90341/14

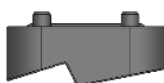

SOTTO PIEDE SP10
90341 / 12

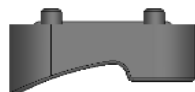

SOTTO PIEDE SP12
90341 / 1



CHIAVE ESAGONALE 6
9331 / 148

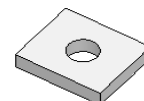

PIASTRINA
90341 / 21



DISTANZIALE
90341 / 20



NOTTOLINO + N° COMB.
90341 / 6



SOTTOTAPPO
90241 / 9



TAPPO BARRA
90241 / 6

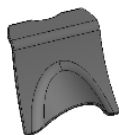

INVOLUCRO POST.
90341 / 9

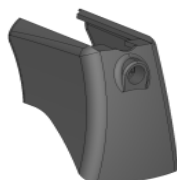

INVOLUCRO ANTERIORE
90341 / 8



CHIAVE + N° COMB
90341 / 7

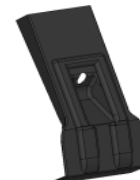

PALETTA
90341 / 4



BARRA ALLUMINIO
90241 / 7



GUARNIZIONE BARRA
90241 / 8



RIGA CARTA
90341 / 19

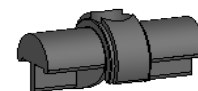

PERNO
90241 / 15



GUARNIZIONE
NUMERICA
91141 / 14

FARAD[®]
made in italy

tel. 011 9713719 - n° verde 800984229

www.faradworld.com

